

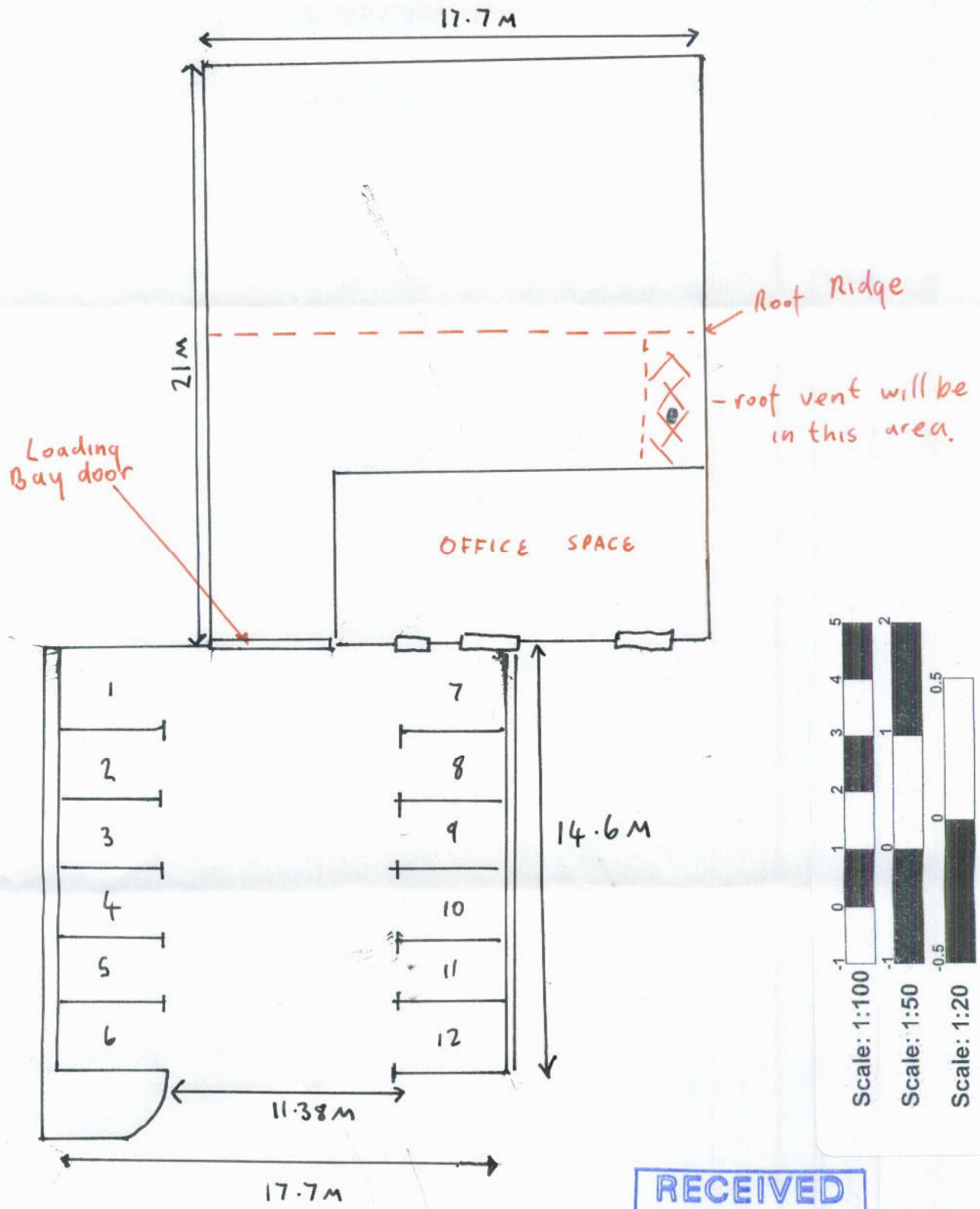

Unit 8 College Fields  
Ground Floor + Parking Plan

①



RECEIVED  
29 AUG 2014

Unit 8 College fields  
front Elevation

(2)

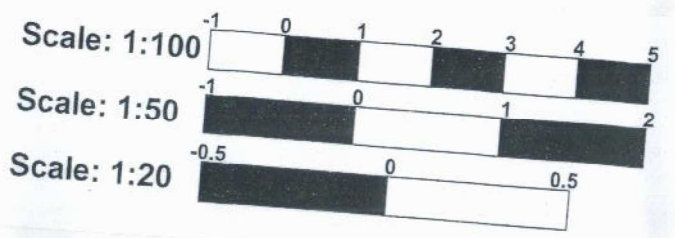

Page 289

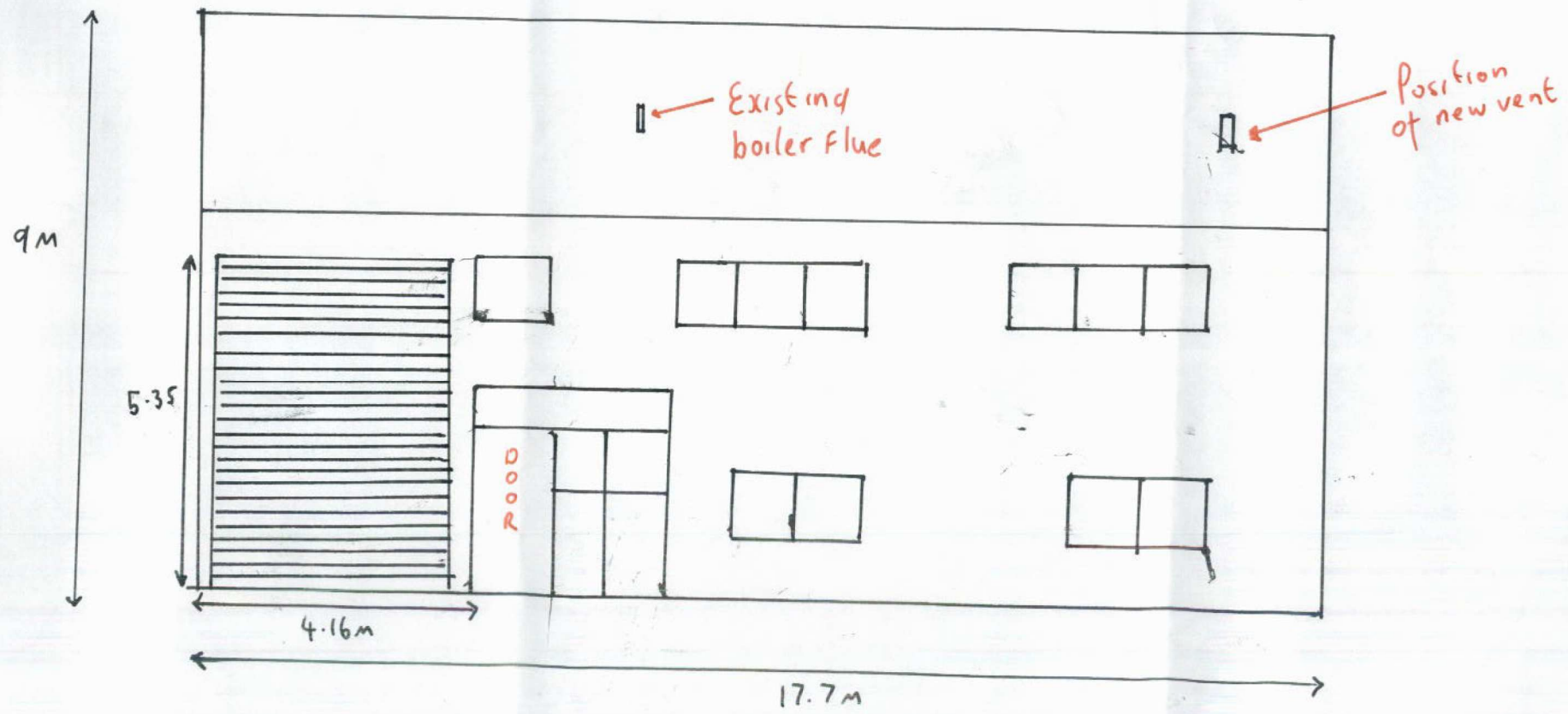

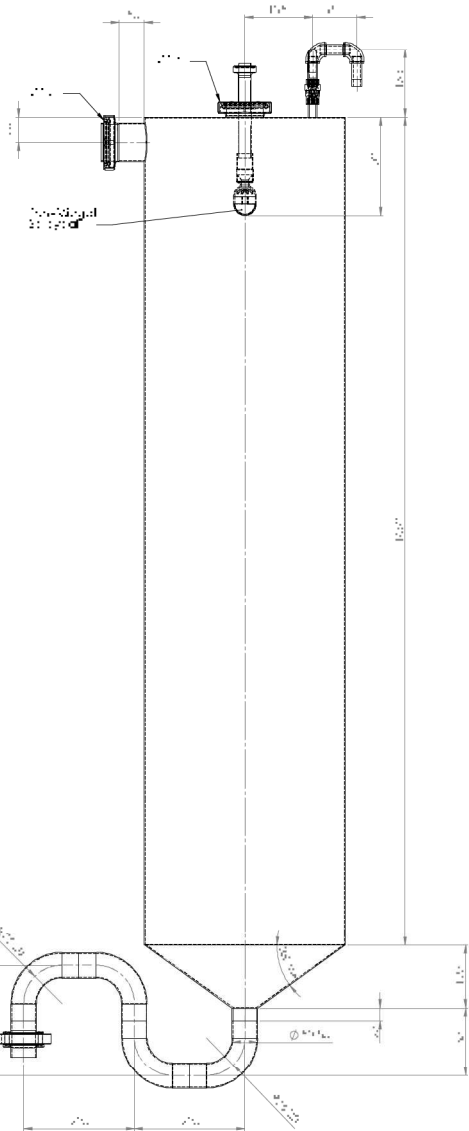
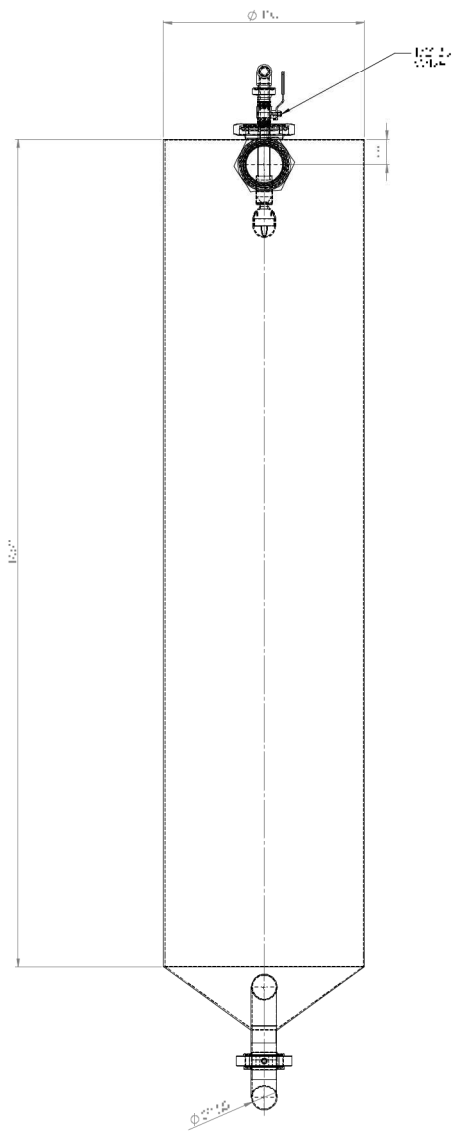
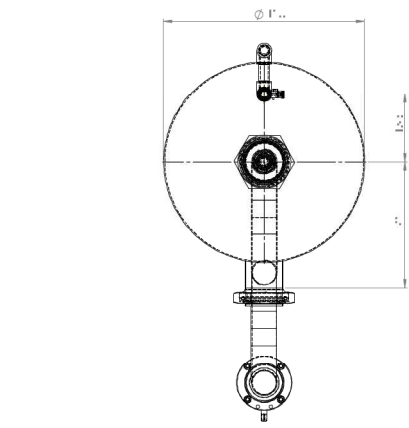

REV	DATE	BY	CHKD

DESIGNED BY	OLYMPUS Automation
CHECKED BY	Waterborough
TITLE	Electr. Pipe Condenser
DATE	
SCALE	



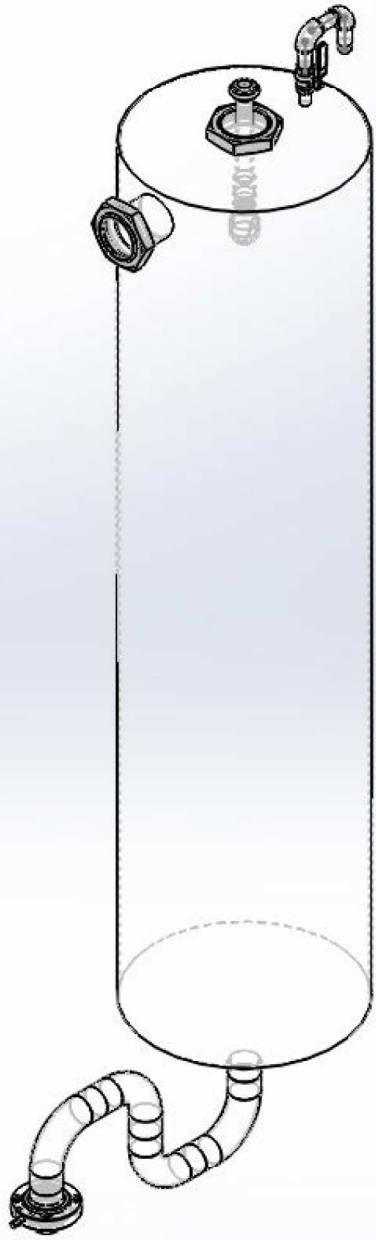

This page is intentionally left blank